



art. 0100

saracinesca a lama senza scarico

cast-iron gate valve with stainless steel knife without discharge

vanne de fer fondu à lame en acier inox sans vidange

Gusseisen-Plattenschieber mit Edelstahl Platten ohne Abfluss

tajadera en hierro con hoja de acero inoxidable sin drenaje

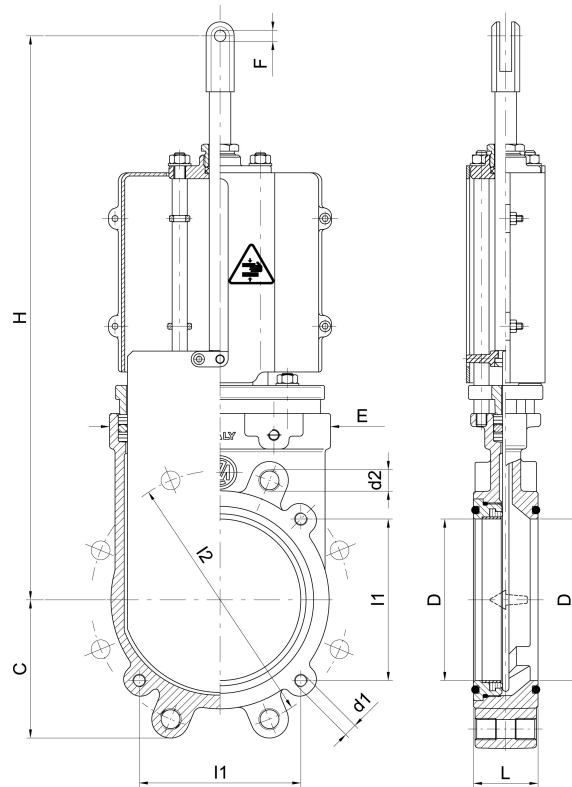
**FLANGE - FLANGES
DIN PN10**

Ø"	I2	d2	fori holes
4"	180	M16	8
6"	240	M20	8
8"	295	M20	8

Senza asta / Without stem

Ø"	Codice / Code	gr
4"	ARZO 0100 100 SMO	8.000
6"	ARZO 0100 150 SMO	14.100
8"	ARZO 0100 200 SMO	19.800

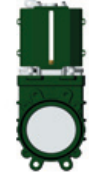

Ø"	Codice / Code	C	D	E	F	H	L	I1	d1	gr
4"	ARZO 0100 100 000	102	100	153	10,5	430	50	150	2xM12	9.000
6"	ARZO 0100 150 000	130	150	221	10,5	523	60	150	4xM12	15.500
8"	ARZO 0100 200 000	156	200	273,5	10,5	611	60	180	4xM12	21.000

Con cilindro art. 0570-0575 / With cylinder item 0570-0575

Ø"	Codice / Code	h	H	gr
4"	ARZO 0100 100 570	381	565	10.970
6"	ARZO 0100 150 575	463	712	20.300
8"	ARZO 0100 200 575	557	853	26.870

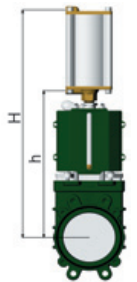
**Con cilindro art. 0500-0501 / With cylinder item 0500-0501**

Ø"	Codice / Code	h	H	gr
4"	ARZO 0100 100 500	371	810	11.590
6"	ARZO 0100 150 500	457	898	18.000
8"	ARZO 0100 200 501	550	1.362	30.000

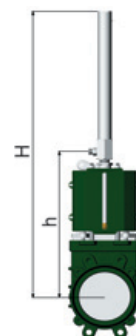
**Con cilindro art. 0550-0551 / With cylinder item 0550-0551**

Ø"	Codice / Code	h	H	gr
4"	ARZO 0100 100 550	376	625	10.160
6"	ARZO 0100 150 551	458	713	16.400
8"	ARZO 0100 200 551	552	847	22.360

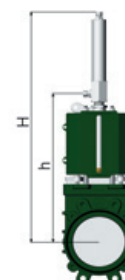
**Con cilindro art. 0571-0576 / With cylinder item 0571-0576**

Ø"	Codice / Code	h	H	gr
4"	ARZO 0100 100 571	381	565	11.000
6"	ARZO 0100 150 576	463	712	20.330
8"	ARZO 0100 200 576	557	853	26.900

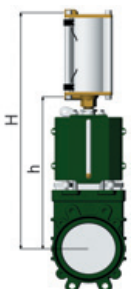

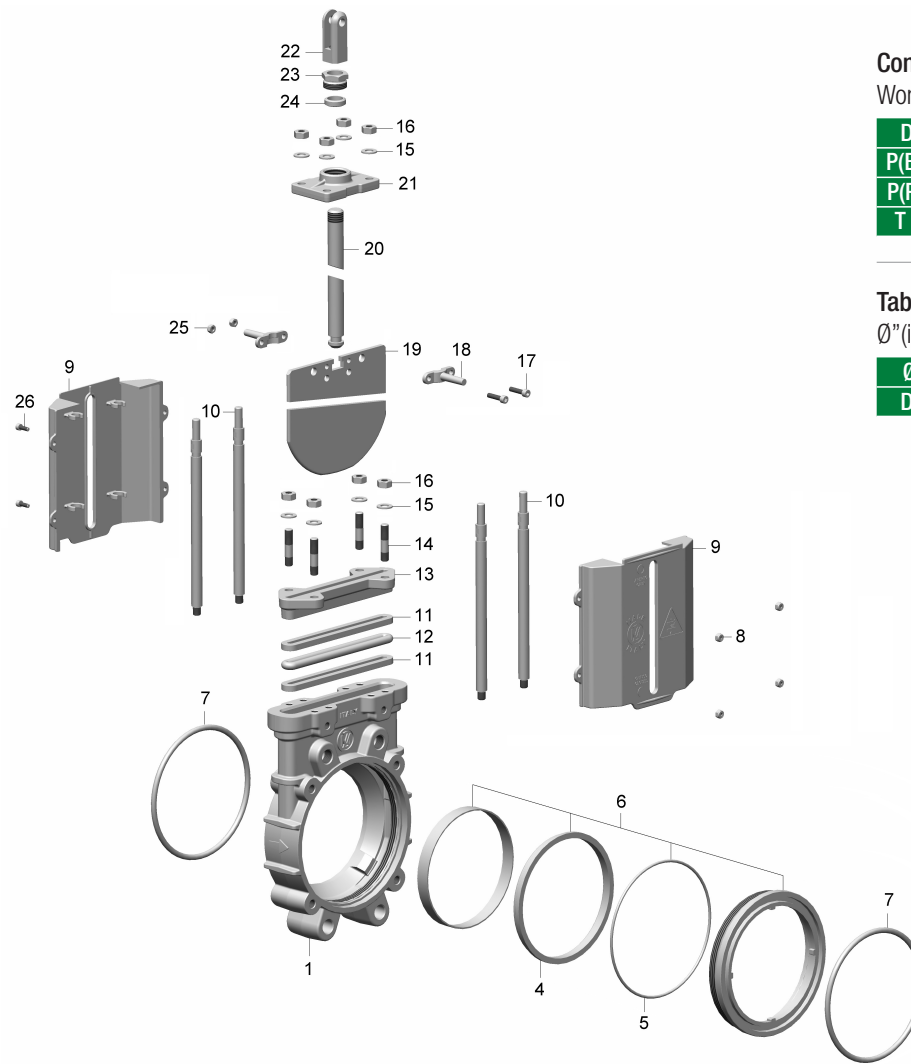
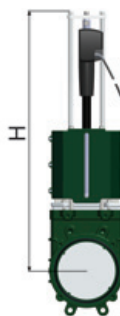
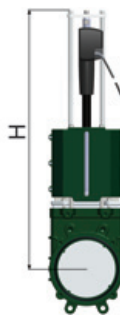
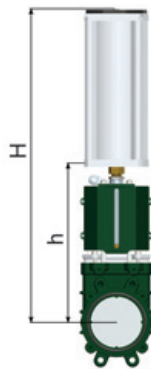

Condizioni di esercizio

Work conditions

DN	4" - 6"	8"
P(Bar)	10	8
P(PSI)	145	110
T °C	-15 +80	

Tabella conversione Ø"(in) - DN (mm)

Ø"(in) - DN (mm) conversion table

Ø"	4"	6"	8"
DN	100	150	200

Con cilindro art. 0580-0585 / With cylinder item 0580-0585

Ø"	Codice / Code	h	H	gr
4"	ARZO 0100 100 580	380	664	15.450
6"	ARZO 0100 150 585	461	930	39.900

Con cilindro art. 0611 / With cylinder item 0611

Ø"	Codice / Code	H	gr
6"	ARZO 0100 150 611	762	19.200
8"	ARZO 0100 200 611	898	23.750

Con cilindro art. 0613 / With cylinder item 0613

Ø"	Codice / Code	H	gr
6"	ARZO 0100 150 613	762	19.200
8"	ARZO 0100 200 613	898	23.750

POS.	CODICE / CODE	DENOMINAZIONE	DENOMINATION	MATERIALE	MATERIAL
1	FGZO 0100 (DN) 001	CORPO "EURO" Ø"...	BODY "EURO" Ø"...	GHISA G250 UNI EN 1561	G250 UNI EN 1561 CAST IRON
4	GGOM 0090 (DN) 004	ANELLO DI TENUTA Ø"...	ESTATE RING Ø"...	GOMMA EPDM	EPDM RUBBER
5	..OR 0090 100 017	OR 4512 (Øi129,80 × 3,53) 4"	O RING 4512 (Øi129,80 × 3,53) 4"	GOMMA NBR 70	NBR 70 RUBBER
5	..OR 0090 150 017	OR 4675 (Øi171,05 × 3,53) 6"	O RING 4675 (Øi171,05 × 3,53) 6"	GOMMA NBR 70	NBR 70 RUBBER
5	..OR 0090 200 017	OR 4875 (Øi221,85 × 3,53) 8"	O RING 4875 (Øi221,85 × 3,53) 8"	GOMMA NBR 70	NBR 70 RUBBER
6	SEMI 0090 100 008	MANICOTTO 4" CON GUARNIZIONI	SLEEVE 4" WITH GASKETS		
6	SEMI 0100 150 008	MANICOTTO 6" CON GUARNIZIONI	SLEEVE 6" WITH GASKETS		
6	SEMI 0100 200 008	MANICOTTO 8" CON GUARNIZIONI	SLEEVE 8" WITH GASKETS		
7	..OR 0090 100 015	OR 206 (Øi127,0 × 5,34) 4"	O RING 206 (Øi127,0 × 5,34) 4"	GOMMA NBR 70	NBR 70 RUBBER
7	..OR 0020 100 010	OR 225 (Øi159,5 × 6,99) 6"	O RING 225 (Øi159,5 × 6,99) 6"	GOMMA NBR 70	NBR 70 RUBBER
7	..OR 0100 200 010	OR 241 (Øi208,92 × 6,99) 8"	O RING 241 (Øi208,92 × 6,99) 8"	GOMMA NBR 70	NBR 70 RUBBER
8	DAAC 0090 150 023	DADO AUTOBLOCCANTE M5	SELF-LOCKING NUT M5	ACCIAIO INOX AISI 304	AISI 304 STAINLESS STEEL
9	SPZO 0090 (DN) 012	CALOTTA DI CHIUSURA Ø"...	CLOSING CAP Ø"...	NYLON + VETRO	NYLON + GLASS
10	TAZO 0090 (DN) 010	COLONNA Ø14 Ø"...	STEM Ø14 Ø"...	ACCIAIO INOX AISI 304	AISI 304 STAINLESS STEEL
11	GUNY 0090 (DN) 013	ANELLO TRECCIA 8×8 Ø"...	BRAID RING 8×8 Ø"...	SINTETICO + PTFE	SYNTHETIC + PTFE
12	GGOM 0090 (DN) 014	ANELLO OR Ø10 Ø"...	O RING Ø10 Ø"...	GOMMA EPDM	EPDM RUBBER
13	FAZO 0090 (DN) 006	PREMITRECCIA Ø"...	GASKET PRESSER Ø"...	ALLUMINIO	ALUMINIUM
14	VTAC 0090 150 011	PRIGIONIERO M10×48	STUD M10×48	ACCIAIO INOX AISI 304	AISI 304 STAINLESS STEEL
15	ROAC 0090 150 016	ROSETTA Ø20 × 10,5 × 2	WASHER Ø20 × 10,5 × 2	ACCIAIO INOX AISI 304	AISI 304 STAINLESS STEEL
16	DAAC 0090 150 015	DADO M10	NUT M10	ACCIAIO INOX AISI 304	AISI 304 STAINLESS STEEL
17	VTAC 0090 150 020	VITE TCEI M6×25 (4"-6")	SCREW TCEI M6×25 (4"-6")	ACCIAIO INOX AISI 304	AISI 304 STAINLESS STEEL
17	VTAC 0080 200 020	VITE TE M8×30 (8")	SCREW TE M8×30 (8")	ACCIAIO INOX AISI 304	AISI 304 STAINLESS STEEL
18	SOZO 0090 (DN) 018	MORSETTO INDICE Ø"...	INDICATOR CLAMP Ø"...	OTTONE UNI EN 12165	UNI EN 12165 BRASS
19	SAZO 0090 (DN) 002	LAMA Ø"...	KNIFE Ø"...	ACCIAIO INOX AISI 304	AISI 304 STAINLESS STEEL
20	TOZO 0040 100 003	ASTA 4"	STEM 4"	OTTONE UNI EN 12164	UNI EN 12164 BRASS
20	TOZO 0040 150 003	ASTA 6"	STEM 6"	OTTONE UNI EN 12164	UNI EN 12164 BRASS
20	TOZO 0074 200 003	ASTA 8"	STEM 8"	OTTONE UNI EN 12164	UNI EN 12164 BRASS
21	SOZO 0090 150 005	TESTATA	HEAD	OTTONE UNI EN 12165	UNI EN 12165 BRASS
21	SOZO 0090 200 005	TESTATA 8"	HEAD 8"	OTTONE UNI EN 12165	UNI EN 12165 BRASS
22	FOZO 0040 100 008	FORCELLA	FORK	OTTONE UNI EN 1982	UNI EN 1982 BRASS
23	TOZO 0040 100 007	PREMISTOPPA M30×2 (4"-6")	NUT M30×2 (4"-6")	OTTONE UNI EN 12164	UNI EN 12164 BRASS
23	TOZO 0074 200 007	PREMISTOPPA M35×2 (8")	NUT M35×2 (8")	OTTONE UNI EN 12164	UNI EN 12164 BRASS
24	SPZO 0040 100 006	GUARNIZIONE Ø27 × 20 × 8 (4"6")	GASKET Ø27 × 20 × 8 (4"6")	POLIMERO	POLYMER
24	SPZO 0030 100 006	GUARNIZIONE Ø32 × 22,5 × 8 (8")	GASKET Ø32 × 22,5 × 8 (8")	POLIMERO	POLYMER
25	DAAC 0080 150 021	DADO AUTOBLOCCANTE M6 4"-6"	SELF-LOCKING NUT M6 4"-6"	ACCIAIO INOX AISI 304	AISI 304 STAINLESS STEEL
25	DAAC 0080 200 021	DADO AUTOBLOCCANTE M8 8"	SELF-LOCKING NUT M8 8"	ACCIAIO INOX AISI 304	AISI 304 STAINLESS STEEL
26	VTAC 0090 150 022	VITE TCEI M5×14	SCREW TCEI M5×14	ACCIAIO INOX AISI 304	AISI 304 STAINLESS STEEL